

B-B

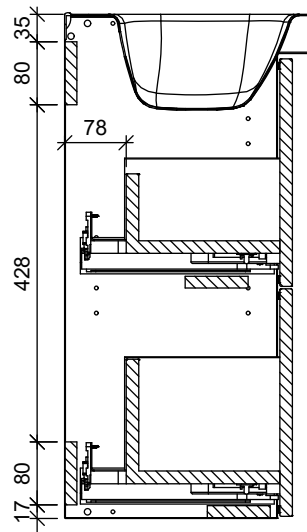
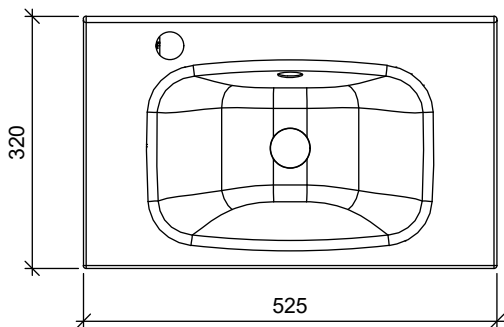

A-A

Osa	Piirustusnumero Tavaratunnus	Osan tai kokoonpanoryhmän kuvaus	Standardi tai luettelo	Muoto, malli Lajimerkki	Määrä	Laatu	Kpl
Yleistoleranssit		Mittakaava	Tuote ALLASKAAPPI	STELLA ALLASKAAPPI			
Massa		1:10	Liittyy	2 LAATIKKOA			
Suunn	2019-10-31 JS		Projekti ALLASKAAPIT	Ent.			
Tark.			TEMAL OY	Uusi			
Hyv.			Runeberginkatu 4 C 00100 Helsinki	Puh: 010 217 2300 Fax: 010 217 2301	MSL525320K		