

SVEDBERGS

S Innehållsförteckning

FI Sisällysluettelo

N Innholdsfortegnelse

GB Index

DK Indholdsfortegnelse

RU Содержание

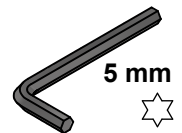
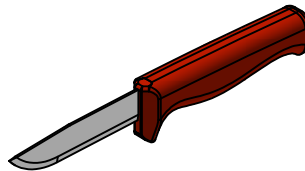
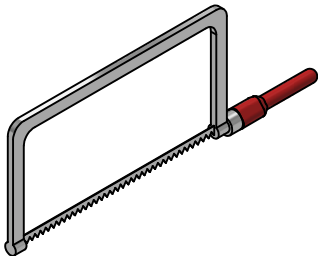
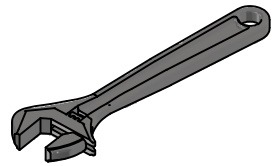
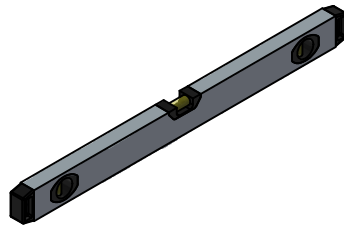
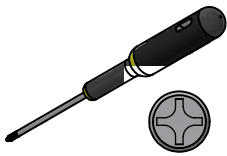

6218

A1

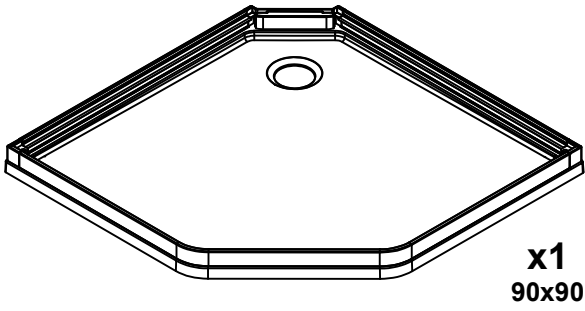

A2

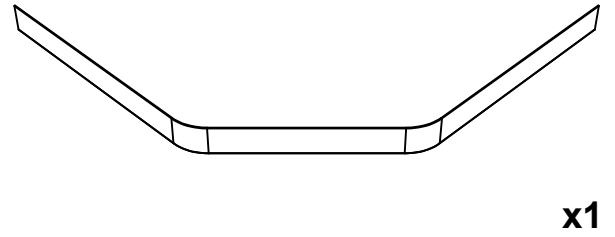

A3

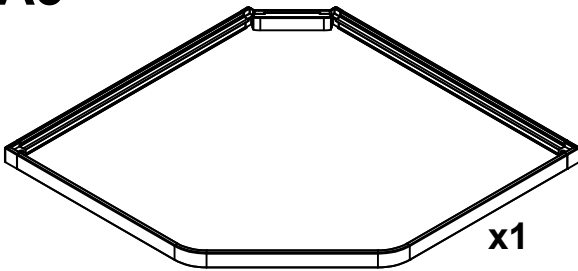

A4

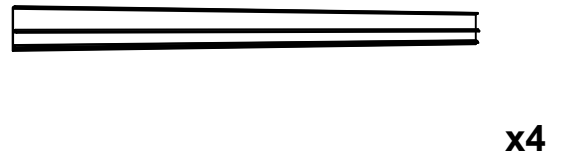

104316

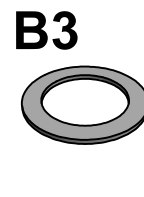
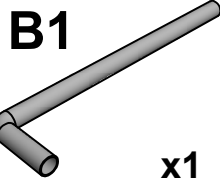

4213

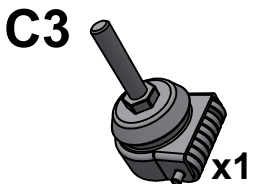
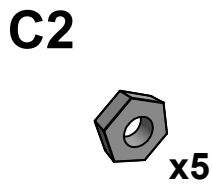
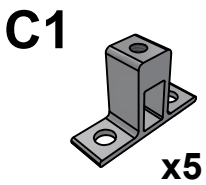

101068

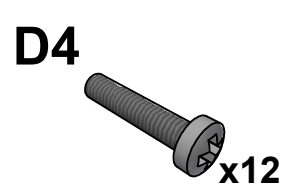
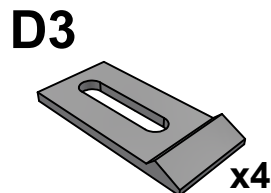
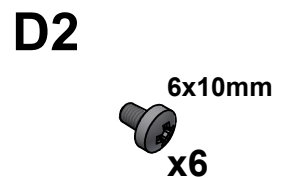
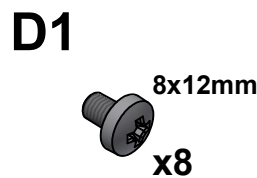

E1

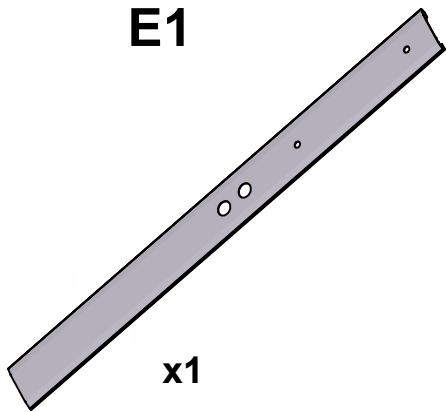

x1

E2

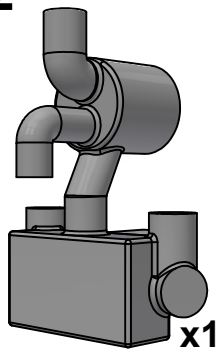

x1

E3



x1

E4

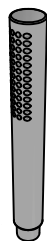

x1

E5

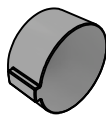

x2

E6



x2

101726

F1

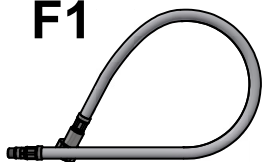

x1

F2



x1

F3



x2

96822

G1

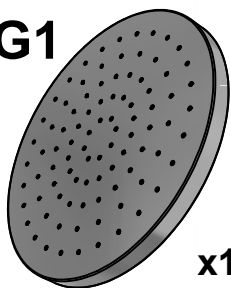

x1

G2

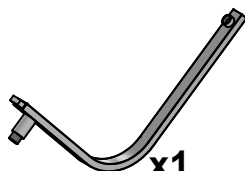

x1

G3

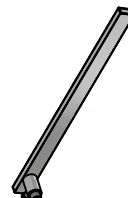

x1

67599
68699

H1

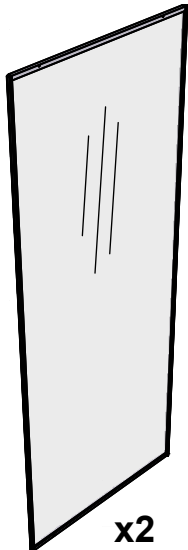

x2

H2



x2

I1

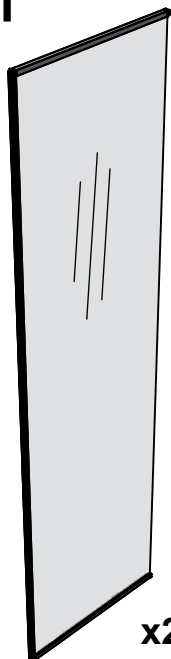

x2

67099

I2

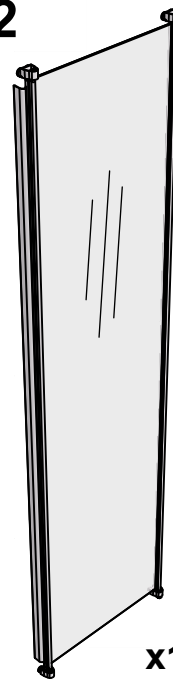

x1

I3



x2



S Reservdelistsla

N Reservedelsliste

DK Reservedelsliste

FI Varaosalista

GB Spare part list

RU Список запасных деталей

Pos.	Ant/Qty	Art.no.
A1	1	6218
A2	1	100817
A3	1	6218
B1	1	103057
B2	1	103141
B3	1	103141
C1	5	4213
C2	5	4213
C3	1	4213
C4	4	4213
D1	8	101068
D2	6	101068
D3	4	101068
D4	12	101068
E3	1	101089
E4	1	4537
F1	1	101726
F2	1	101726
F3	1	101726
G1	1	96822
G2	1	96822
G3	1	96822
H1	2	8757 / 104118
H2	2	101006
I1	2	101762
I2	1	101061
I3	1	3731

S Spara reservdelistslan för eventuella framtida behov.

FI Säilytä varaosalista mahdollista tulevaa tarvetta varten.

N Ta vare på reservedelslisten for eventuelle fremtidige behov.

GB Save the spare part list for future references.

DK Gem reservedelslisten til senere brug.

RU Сохраните список запасных деталей для дальнейшего возможного использования.

101728

Rev.no 2022-01-05