

Antal	Beskrivning
-------	-------------

1	UNILIFT APG.40.10.3
---	---------------------



OBS! Bilden på produkten kan avvika från aktuell produkt

Art.nr.: [92616893](#)

The UNILIFT APG pump is a single-stage submersible pump designed for pumping domestic wastewater. The pump is equipped with a grinder system that grinds destructible solids into small pieces to lead them through pipes with a relatively small diameter.

UNILIFT APG pumps are ideal for use in sparsely populated areas, where gravity sewage systems are not available. The solution is ideal in, for example, one-family or two-family houses, residential building services and areas with large terrain-level differences.

The pump is available for two types of installation:

{_BL_}

submerged installation on auto-coupling systems.

submerged installation, free-standing.

The pump is made of wear-resistant materials, such as cast iron and stainless steel.

These materials ensure reliable operation.

The surface of the pump is smooth to prevent dirt and impurities from sticking.

Four corrosion-resistant screws secure the motor to the pump housing and allow for easy service of the pump.

92616893 UNILIFT APG.40.10.3 50 Hz

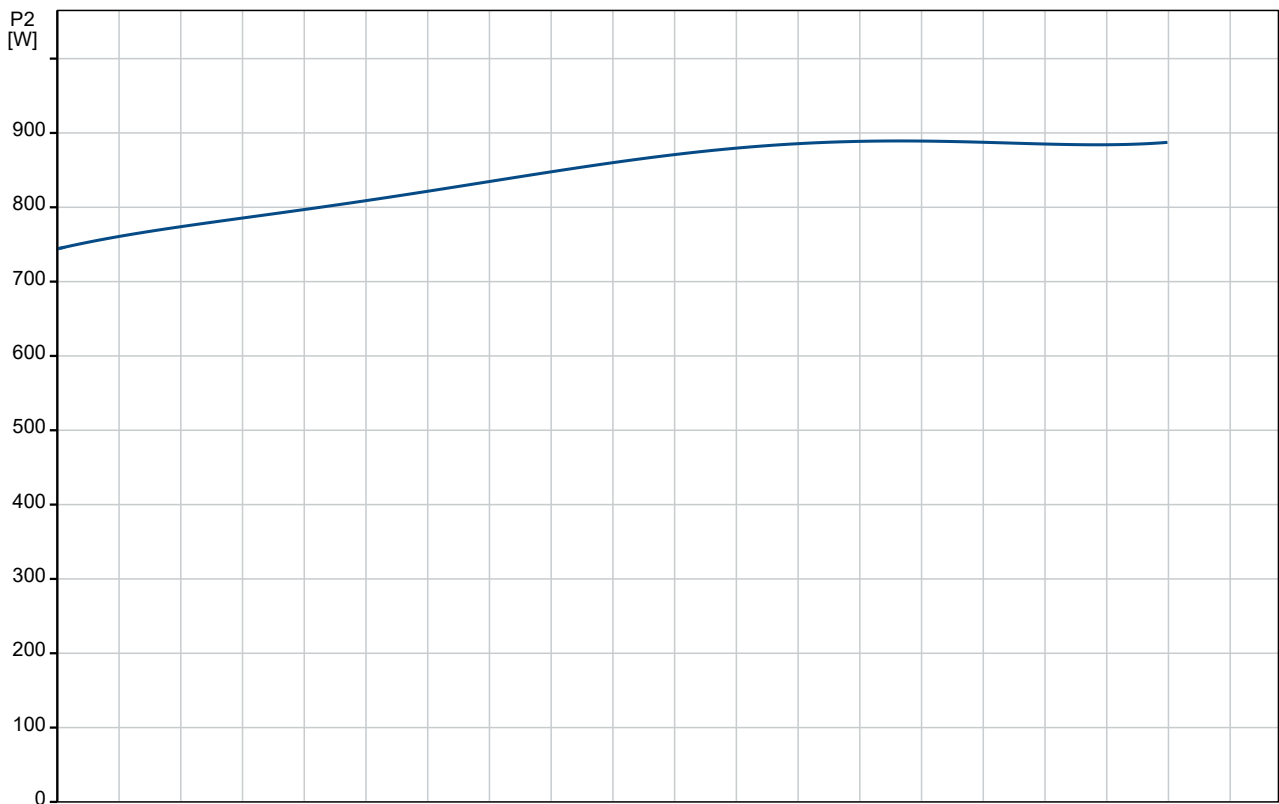
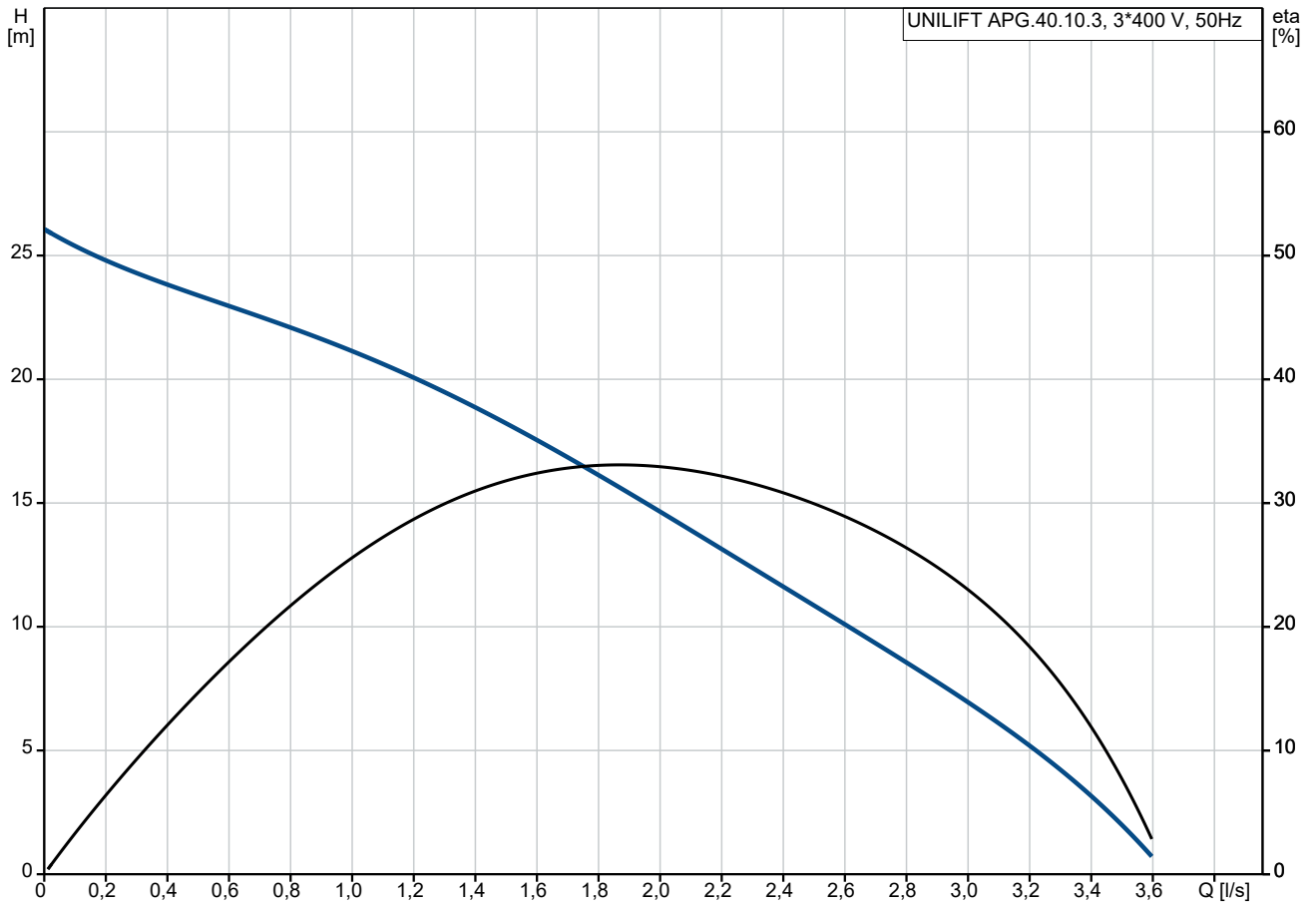

Beskrivning	Värde
Generell information:	
Produktnamn:	UNILIFT APG.40.10.3
Art. nr:	92616893
EAN nummer:	5715117128183
Tekniskt:	
Nominellt flöde:	2 l/s
Nominellt tryck:	15 m
Typ av pump/hjul:	Grinder system
Max. Partikel:	40 mm
Godkännanden:	CE,EAC,LGA,UKCA,SEPRO
Modell:	A
Nominellt drivenhetsvarvtal:	2850 Varvtal
Material:	
Pumphus:	Gjutjärn
Pumphus:	EN 1561 EN-GJL-200
Pump/hjul:	Composite
Pump/hjul:	PPE-PS-GF30
Motor house:	Cast iron
Motor house:	EN 1561 EN-GJL-200
Installation:	
Område för omgivande temperatur:	0 .. 40 °C
Typ av utloppsanslutning:	DIN / Rp
Storlek på trycksida:	DN 32/40
Trycksteg för röranslutning:	PN 10
Maximum installation depth:	7 m
Vätska:	
Vätsketemperatur område:	0 .. 70 °C
Densitet:	998.2 kg/m ³
Elektriskdata:	
Tillförd effekt P1:	1.1 kW
Nominell effekt – P2:	1 kW
Nätfrekvens:	50 Hz
Nominell spänning:	3 x 400 V
Nominell ström:	2.8 A
Nominellt drivenhetsvarvtal:	2850 Varvtal
Kapslingsklass (EC 34-5):	IP68
Isolationsklass (IEC 85):	F
Längd strömförsörjningskabel:	10 m
Strömkontakt:	No plug
Styrningar:	
Float switch (Yes/No):	N
Övriga:	
Bruttovikt:	24.8 kg
Leveransvolym:	0.037 m ³
Försäljningsområde:	Europe
Danskt VVS No.:	391331511
Svenskt RSK nr.:	5885560
Finskt:	4836187
Norskt NRF nr.:	9045608
Ursprungsland:	HU
Varukod:	84137021
Environmental approvals:	WEEE

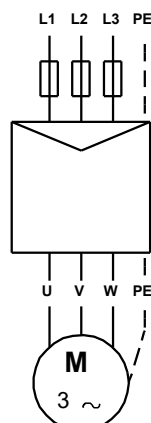
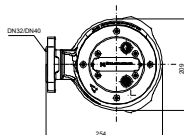
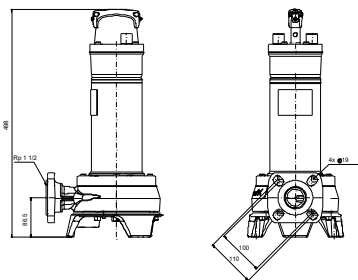
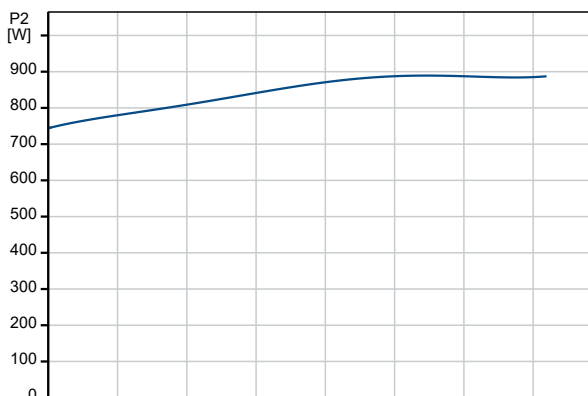
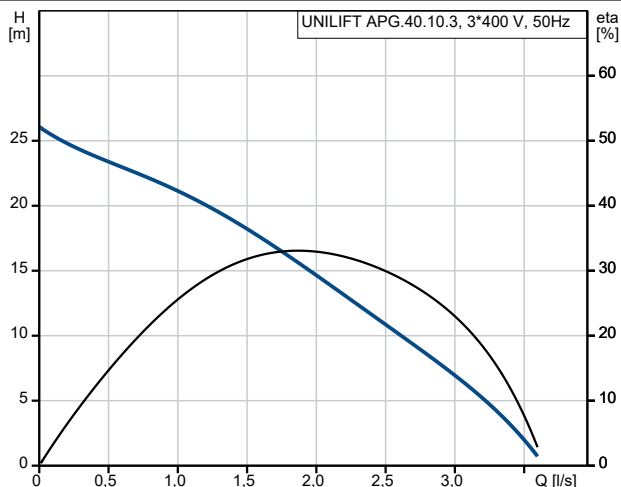

92616893 UNILIFT APG.40.10.3 50 Hz

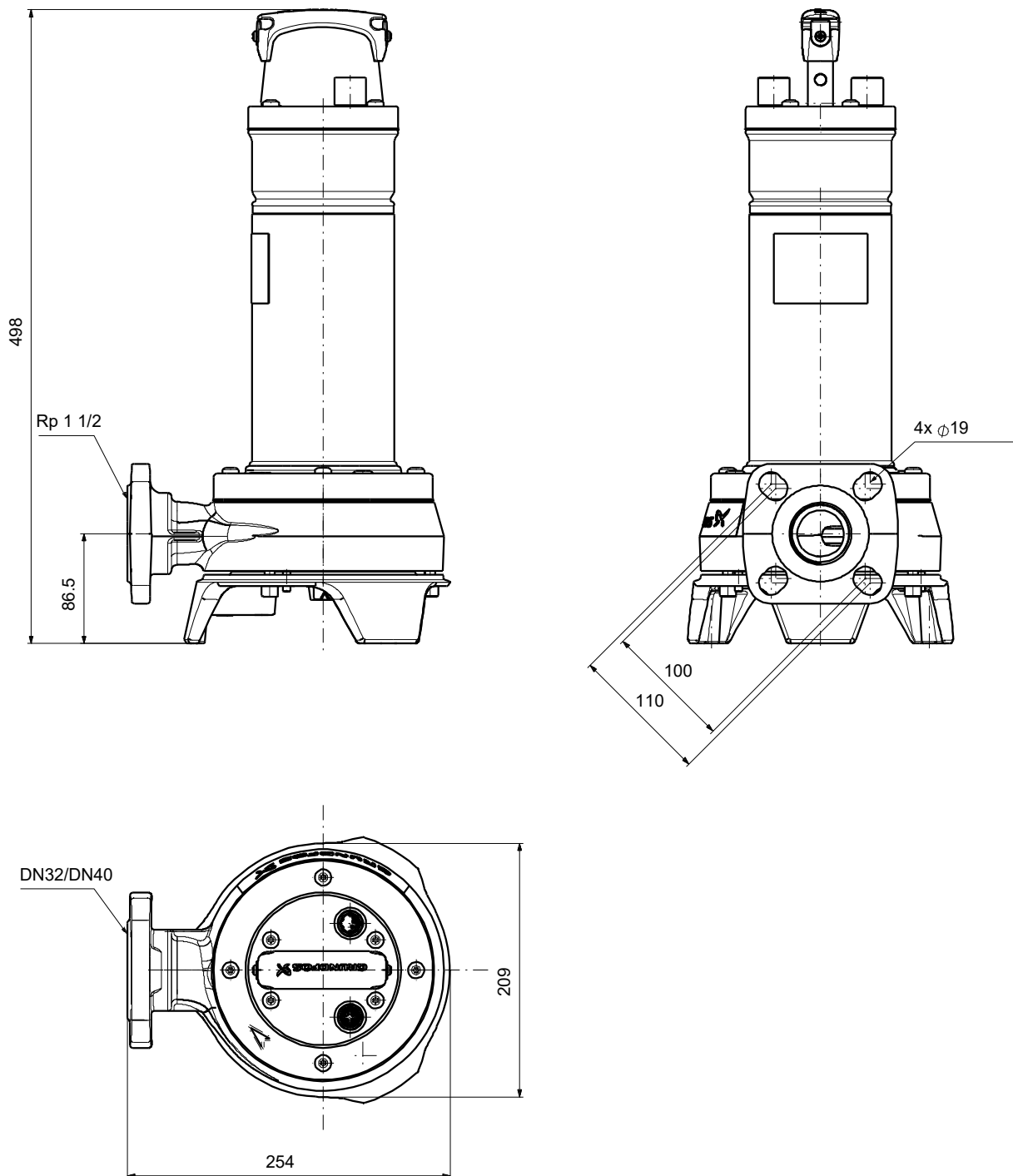

OBS! Alla mått anges i (mm) om inte annat anges. Ansvarsfriskrivning: Denna förenklade måttskiss visar inte alla detaljer.

92616893 UNILIFT APG.40.10.3 50 Hz

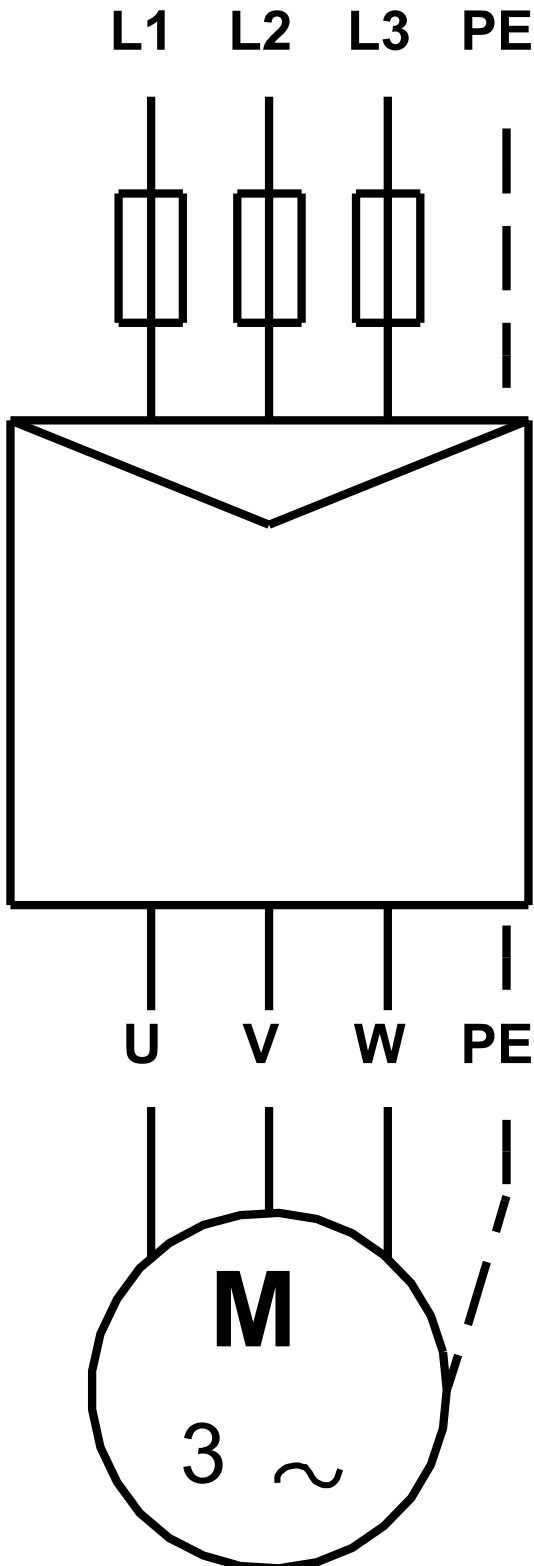

OBS! Alla enheter anges som [mm] om inget annat visas.